

Product detail parameters

MODEL	BEP150S	BEP300A	BEP500SA	BEP600S	BEP800S	
Output	Rated Power	150W	300W	500W	600W	800W
	Peak Power	300W	600W	1000W	1200W	1600W
	Frequency					
	WaveForm					
Input	Battery Voltage	12V /24V (Optional)	12V / 24V / 48V(Optional)			
	Voltage Range	10-15V(12V) / 20-30V(24V) / 40-60V(48V)				
	No load Current	0.6A(12V) 0.3A(24V)	0.8A(12V) 0.6A(24V) 0.3A(48V)	0.8A(12V) 0.6A(24V) 0.3A(48V)	0.6A(12V) 0.3A(24V)	0.8A(12V) 0.6A(24V) 0.3A(48V)
	Efficiency	≥90%				
Battery input protection	Low Voltage Alarm	11(12V) / 21V(24V) / 42V(48V)				
	Battery low voltage protection	10V±0.5V(12V) / 20V±0.5V(24V) / 40V±0.5V(48V)				
	Battery high voltage protection	15V±0.5V(12V) / 30V±0.5V(24V) / 60V±0.5V(48V)				
	Battery reverse polarity protection	NO	YES	YES	YES	NO
Other protection	High temperature protection, Shortcircuit Protection, Overload Protection					
USB	5V / 500mA					
FAN	Smart fan, Automatic startup of high temperature and load					
Operating environment	Temperature 0°C~40°C@100%load, Humidity 20%~90%RH, No refrigeration					
Size(mm)	160*95*55	172*150*58	260*150*78	262*150*76	309*180*172	
Weight(g)	530	910	1700	1800	3050	

MODEL	BEP1000S	BEP1500S	BEP2000S	BEP3000S	BEP5000S	
Output	Rated Power	1000W	1500W	2000W	3000W	5000W
	Peak Power	2000W	3000W	4000W	6000W	10000W
	Frequency	50Hz / 60Hz(Optional)				
	WaveForm	Pure Sine Wave				
Input	Battery Voltage	12V / 24V / 48V(Optional)				12V / 24V (Optional)
	Voltage Range	10-15V(12V) / 20-30V(24V) / 40-60V(48V)				
	No load Current	0.8A(12V) 0.6A(24V) 0.3A(48V)	1.8A(12V) 1.0A(24V) 0.5A(48V)	3.0A(12V) 1.5A(24V) 0.8A(48V)	3.8A(12V) 2.0A(24V) 1.2A(48V)	2.5A(24V) 1.4A(48V)
	Efficiency	≥90%				
Battery input protection	Low Voltage Alarm	11(12V) / 21V(24V) / 42V(48V)				
	Battery low voltage protection	10V±0.5V(12V) / 20V±0.5V(24V) / 40V±0.5V(48V)				
	Battery high voltage protection	15V±0.5V(12V) / 30V±0.5V(24V) / 60V±0.5V(48V)				
	Battery reverse polarity protection	NO				
Other protection	High temperature protection, Shortcircuit Protection, Overload Protection					
USB	5V / 500mA					
FAN	Smart fan, Automatic startup of high temperature and load					
Operating environment	Temperature 0°C~40°C@100%load, Humidity 20%~90%RH, No refrigeration					
Size(mm)	367*150*76	452*150*142	454*180*142	529*180*142	585*180*167	
Weight(g)	2750	4000	4900	6020	8000	
Remarks : Please select the corresponding parameters according to the						

This series of pure sine wave inverter is suitable for:

Household appliances: TV, refrigerator, freezer, washing machine, air conditioner, power amplifier, induction cooker, electric fan, electric cooker Lamps and lanterns, AV equipment.....
Power tools: electric drills, pumps, cutting machines, motors, hand mills.....
Office equipment: computers, printers, copiers, fax machines, network equipment.....
On-board equipment : inverter can be connected to the car capacitor, suitable for all kinds of on-board appliances.



WARNING

To avoid harm to you and others, here are some of the following security considerations. Be sure to follow the meanings of the various flags. See the following.



Inflammable gas

- When connected to a battery, sparks are produced. Make sure there is no flammable gas before connecting.
- The battery will produce flammable gas when charging and discharging. It should be well ventilated and should not be stored in other places where it is flammable



No parallel with city power

- The output can not be paralleled with the power supply, it will damage the inverter and cause the danger of electric shock.



Minors are prohibited from using them

- Can not be used by minors, inverter output is high voltage, may lead to electric shock risk.



No disassembly or assembly

- Do not disassemble or modify the inverter without permission. Unauthorized removal or modification of the inverter may result in a safety accident such as a malfunction, fire or electric shock.



Bar contacts are prohibited

- Do not place bars or other metal objects at the opening or socket of the inverter. This may touch the internal parts and cause electric shock and inverter damage



Wet hands, do not touch

- Do not touch the body and plug with wet hands, which may cause electric shock and personal safety



Keep away from fire and high temperatures

- Fire and explosion can occur in inverter and battery when running in flame and high temperature region.



No throwing

- Bumping the inverter can cause damage and other safety hazards.



Medical equipment disabled

- This inverter has not been tested and can not be used in medical equipment



Please connect the ground wire.

- In order to ensure the safety of use, please connect the ground wire.



Moisture proof and waterproof

- Please pay attention to moisture proof and waterproof. The inverter may cause short circuit, fire and electric shock due to humidity or water inflow.



Please insert completely

- Please insert the load device plug into the inverter socket completely. If the plug is fully inserted at the end, it may lead to electric shock and overheating, and even cause a fire accident. Do not use damaged plugs, power outlets, electrical wires.

BELTTT®

Power Inverter

Solar Power Generation System

**BEP150S / BEP300A / BEP500SA
 BEP600S / BEP800S / BEP1000S
 BEP1500S / BEP2000S
 BEP3000S / BEP5000S**

Pure Sine Wave Inverter Manual

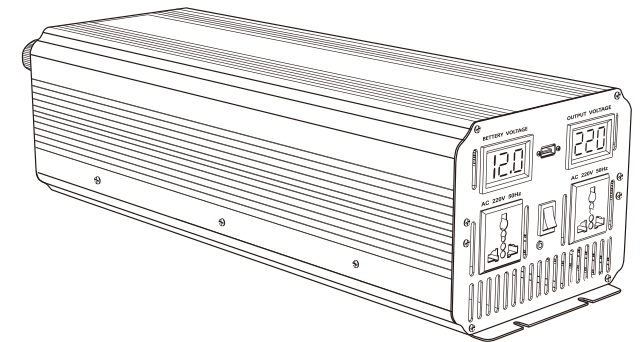

To ensure reliable service, the inverter must be used properly. Please read the instruction manual before use. Particular attention should be paid to the warning and attention of this brochure. Caution for certain conditions and practices that may cause damage to the inverter. Make clear warning statements about certain conditions and practices that may cause bodily harm. Please read all instructions before using the inverter.

Please read this instruction manual carefully so that it can be used correctly. Remember to read the "safety precautions" section before you use it to make sure it's safe to use. After reading the instructions, please complete the warranty card for safekeeping, to keep on for reference.

Product characteristics

- The inverter is equipped with perfect protection circuit. Provide safe automatic shutdown function, including overload protection, input high-low voltage protection, to prevent damage to your inverter;
- The inverter has advanced anti-interference technology, fully functional protection circuit and soft start circuit, convenient operation mode;
- modify the string wave output, inverter provides AC, USBoutput interface;
- instantaneous power up to 1000W, efficiency as high as 94%.

Pure sine wave inverter front and rear panel diagram

BEP150S Panel diagram

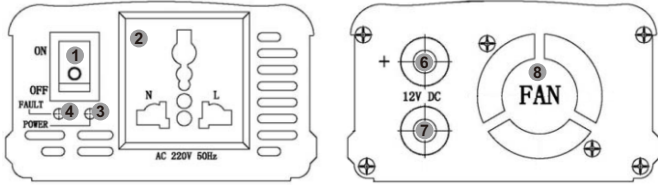

BEP300A/500SA Panel diagram

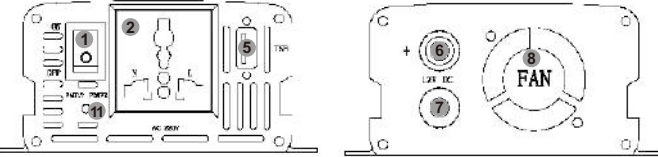

BEP1000S Panel diagram

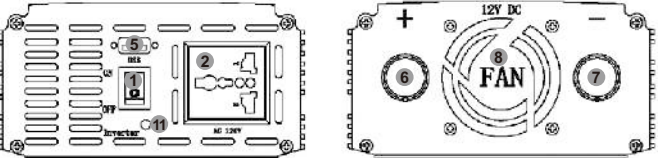

BEP800S/1500S/2000S/3000S Panel diagram

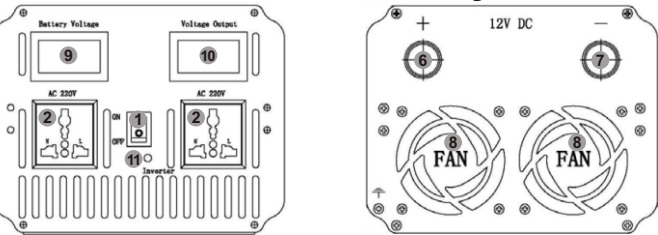

BEP5000S Panel diagram

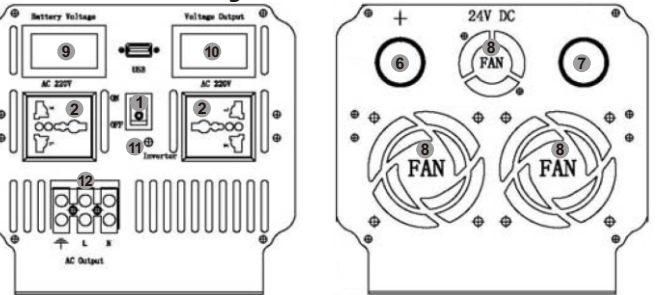

1. Power switch
2. AC output socket
3. Power indicator
4. Status indicator
5. USB Interface
6. Positive (red)
7. Negative (black)
8. Cooling fan
9. Voltage input monitor
10. Voltage output monitor
11. Double color status indicator
12. AC output interface

The product panel is for reference only. Please refer to the actual product.

Install the connection step:

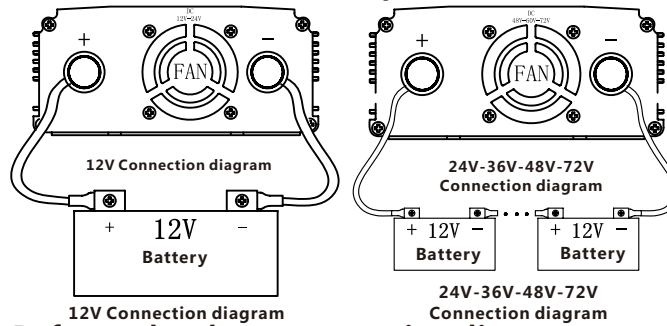

Refer to the above connection diagram

1. First turn off the power switch of the inverter.
2. Use a black DC cable to connect the negative terminal of the battery to the black terminal of the inverter.
3. Connect the positive terminal of the battery to the red terminal of the inverter with a red DC cable.
4. Plug the power supply plug of the power equipment into the output socket of the inverter.
5. Open the inverter power switch can be used.

Disassembly steps:

1. First turn off the power switch of the inverter ;
2. Pull out the power plug of the load.
3. Remove the red DC cable ;
4. Remove the black DC cable

For example, when the power of an AC load is 100W, the current supplied by the power supply must be $100/10=10A$. In the need of a larger current, you can use several batteries in parallel to use. The most important thing is to ensure that there is enough cross-sectional area of the connecting cable. This manual does not list all battery pack types. The battery's charging and battery configuration belong to another professional category.

Installation method

1. **Wiring diagram is only for basic reference, please contact professional technical personnel for actual installation.**
One or more batteries can be used in inverters. One or more batteries can be used in inverters. It's better to use 150AH or batteries with bigger capacity.

Warning 2. Since it may be necessary to connect the battery for these operations, make sure there is no flammable gas around before connecting.

Connect the inverter and the battery with the cables supplied with the inverter (excluding the high-power mode cable). The red cable is connected to the red terminal of the inverter input terminal and the positive terminal of the battery. The black cable is connected to the inverter input terminal black and battery negative. Please ensure that all cables are stable and reliable. Improper connection may result in overheating of the cable, damage to terminals and lugs. At the same time will cut down the battery power supply time. Turn the inverter mode to ON, if your battery is fully charged, the light of inverter will display green. The inverter is protected if the light displays red, so try to solve it before using. (Check whether the battery voltage is too high or too low, the inverter output is overload or short circuit) .

The power source for the 12V inverter can be used with a 12V battery or several 12V batteries in parallel to increase the battery's power supply time.

3. **Inverter must be connected to the same nominal voltage of the battery, 12V inverter connected to the 12V battery, 24V inverter connected to the 24V battery**
4. **Before you plug in all your power devices, make sure all devices are shut down.**
Turn on the inverter mode switch, the POWER on the edge of the LED emits green light, and then you can open your device one by one, if your device is not overloaded, now can work properly. If LED glows red, it's overloaded. You need to reduce load restart to work.

• In the installation of connecting cables should use a suitable cable, such as 220V output cable is too long or the wire cross-sectional area is too small, there will be a lot of power loss in the cable, the load side of the performance of small power, low voltage.
• Batteries and inverter connection cable is not standardized, the cable is too long, the cross-sectional area is too small, bad connection parts, will cause a lot of power loss. Performance for the lack of output power, the battery voltage is too low, short working hours, and even turn on the alarm does not work. At the same time the cable should be waterproof, dielectric strength must meet the requirements of the use of the environment.

Performance introduction

An inverter is a power supply that converts direct current (batteries, solar cells, wind turbines, etc.) into alternating current. Because of the high frequency inverter used in power conversion technology, ferrite transformer to replace the old bulky silicon steel transformer. This is why the inverter of our company is lighter weight and less bulky than other inverters that have similar rated power. When the inverter works in the inverter mode, the output waveform is modified sine wave. It is a practical wave which waveform characteristic is similar to pure sine wave. This waveform is most suitable for linear load and switching power supply of electronic equipment, such as light bulbs, rice cookers, energy saving lamps, etc.. It can also be applied to inductive loads, such as transformers, motors, etc.

The correct value of the modified sine wave for inverter output is 220V, which is the same as the standard home power supply. Most AC voltmeters (digital and analog) use sensitive averaged waveforms instead of RMS values.

Their calibration is set at RMS voltage, which is used to measure pure waves. Using them to measure the output voltage of the inverter, it is possible to detect a low voltage 20V-30V. In order to measure accurately, please use the voltmeter which can measure the effective value.

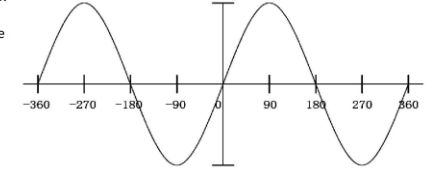

Using environment Pure sine wave

In order to achieve the best use effect, please put the inverter in the surface of the smooth place, such as the ground, the floor of the car, or other solid surface. Let the inverter power line can be fixed easily. The working place should meet the following standards:

1. Do not allow the inverter to contact with water or other liquid to keep the inverter away from moisture or water.
2. In a cool environment, the temperature is 0 degrees (without condensation) to 40 degrees. Don't put the inverter next to the heating vents or other heating devices. Keep the inverter out of the sun as much as possible.
3. Keeping the ventilation and the absence of obstructions around it ensures that air is free to circulate. When the inverter is working, do not put something on the inverter. The inverter fan is used to help dissipate the heat.
4. Be careful not to use inverters near flammable materials or places where flammable gases can be gathered.
5. The battery not only provides a dc voltage of 11V to 15V, but also provides sufficient current to run the load. The power supply should be a good battery full of electricity. To estimate roughly the current required for a load, it can be estimated by dividing the power of the load by 10.

Rated current and actual use of equipment

The nominal current or power of most power tools, household appliances and video and audio equipment is much smaller than the nominal power range of the inverter, but overload protection occurs when they are started. Inverter is the most easy to drive resistive load or switching power supply load. Because the resistive load is a linear load, it can work full load. Such as electric stove, rice cooker, LCD TV and other equipment.

Some audio-visual equipment and electric tools to a greater level than resistive load power can work normally, such as asynchronous motor, CRT TV, compressor, water pump etc. 2 to 6 times the working current is required to start. The ability to run specific loads is subject to test.

Warning Continuous frequently open and close inverters can cause damage. Non-professional technicians, do not open inverter shell

Common problem

Electric tools and microwave ovens cannot start

Carefully read the information on each power tool and accurately determine the input power of the tool. Whether the output power is enough to run the tools and microwave ovens, remember that power tools may need 2 to 6 times power requirements.

Television interference

The inverter has little interference with the television signal. However, in some cases, some disturbances are still visible, especially when the television signal is weak.

Please try the following methods:

1. Try to keep the inverter away from the TV antenna or lengthen the TV antenna cable;
2. Adjust the direction of the inverter.
3. Ensure that the antenna provides strong signal strength to the TV set, and use high quality antenna cable with good shielding effect.
4. When you watch TV, do not run high power electrical equipment or tools.
5. There is no way to completely disappear some of the old TV interference.

Warning Normally the fuse will not burn out unless serious circuit failure occurs. When the inverter fails, please do not try to repair it yourself. Please contact a professional technician to deal with the machine, there will be high voltage electric shock hazard.